



latest instructions

Part Nos:

- BB1210
- BB1215
- BB1225
- BB1240
- BB1270
- BB12120
- BB12200
- BB1224120
- BB122465
- BB1236120
- BB124865
- BB1248120

INC. BBR

TEMP1



Temperature sensor included



STERLING POWER

Sterling Power Products DC/DC Charger Handbook

Saturn Series, full range



RoHS compliant



www.sterling-power.com
www.sterling-power-usa.com

Warranty (2 years return to factory)

Copyright © 2023
Sterling Power
All Rights Reserved



INLEAF FAQs

What charge profile should I choose?

Ultimately, this is something we cannot tell you. There is no purely standardised charge profile for specific battery types and we cannot be expected to know every single battery on the market. Consult with your battery specification sheet or with your battery manufacturer and choose a battery type that most closely fits in with their recommended values. It's better to be underneath what the manufacturer recommends than to be over it.

What does the temperature sensor do?

The temperature sensor, on lead acid, will cause temperature compensation, adjusting the charge voltage up or down depending on the temperature registered at your battery. On lithium charge profiles temperature compensation does not occur, but our charger will not provide any output if it registers 0DEGC at the battery.

Do I need a common negative?

Yes, please. Keep in mind that charging your batteries requires a good circuit. Poor negatives or degrading negatives will negatively (pun unintended) affect your charge capabilities and our calculations.

Cable doesn't fit!

Cable too big is better than cable too small! To downstep your cable into our connectors, either consider using ferrules or dropping the cable size across a contact (fuse holder, bus-bar etc).

Charger isn't doing anything!

If the charger doesn't seem to be running- check a few things. Make sure you're not in Vibration Sense mode (as this will make the unit respond to vibrations ONLY). Make sure you're getting >13.5V on the POS IN and NEG of the charger. Make sure the ignition feed (if fitted!) is getting a live signal when it should be.

I don't want reverse charge!

This can be disabled on the unit itself, covered on page 11.

You drained my starter battery!

Check to make sure that your ignition feed line is only live when the vehicle alternator is running. All of our control signals come from voltages- we will only be on if there's signals telling us to be on.

My charger keeps turning on and off/the charge current is low!

If you seem to have pulsing charge ON/OFF, you probably have a problem with the input voltage to the Saturn charger. Get a voltmeter and sit at the input of the unit and monitor what the input voltage is. If the input voltage sags a lot when the charger turns on, either you have loss down cable/contacts or your alternator is insufficient to support the load. If the voltage is triggering down to <11V for an instant, turning off the charger and then immediately recovering, this is likely being triggered by a faulty resettable fuse on the POS IN line. Replace or bypass the fuse to verify.

How do I care for my charger?

Keep us away from exposed water ingress (we are conformal coated, but be sensible!), keep us away from faulty items (cheap solar regulators sometimes dump a very high solar voltage onto the DC system- this can damage electronics like our Saturn charger!), and check our cable connections frequently, to make sure nothing is vibrating loose.

Can I come straight off of the alternator?

Sadly not. The calculations the DC/DC charger has to make in order to do its job best means that we need a stable input. Without a lead acid starter battery or an ALD (Alternator Linearisation Device) on the input, the alternator voltage can be erratic and severely hamper our charge capabilities. Please follow the install!

Is this safe for my alternator? /How do I rate the BB for my system?

It's safe for your system if it's rated correctly! There's lots of different trains of thought for how to properly rate a BB system- and it is complicated. The guidelines we have followed for years has been rating the system to up to 80% of what your alternator is rated to. There are exceptions to this rule (cheap alternators will want a lower limit, and alternators with custom cooling or unique cooling methods may be able to cope with a higher limit) but 80% or below seems to be the golden point for balancing alternator protection and charge speed.

Can I parallel multiple?

Yes, you can combine two of our battery to battery chargers together to combine their output capabilities. Please install each of them as if the other charger did not exist, IE please do not start trying to wire one charger into the next.

How?

Either combine them using busbars (to split the input and combine the outputs neatly) or wire them each entirely individually to avoid the complications and pitfalls of wiring chargers into one another.



STERLING
POWER

INTRODUCTION TABLE OF CONTENTS

Introduction

- 02 Frequently asked questions
- 03 Table of Contents + Welcome

Safety and Legal

- 04 Legal Guidelines / Warranty Statement
- 05 Safety Guidelines

Product Information

- 06 Basic Wiring Diagram / Installation Orientation
- 07 Unit Specifications and Recommended Fuse/Cabling (1)
- 08 Unit Specifications and Recommended Fuse/Cabling (2)
- 09 Understanding your charger (1)
- 10 Understanding your charger (2)
- 11 Configuring your charger and understanding the display (Battery types)
- 12 3 types of product activation

Troubleshooting

- 13 Troubleshooting and fault finding

Saturn Remote (BBR)

- 14 Understanding your remote
- 15 Configuring your remote

Technical Drawings

- 16 Technical drawings (1)
- 17 Technical drawings (2)

Misc.

- 18 Sterling Contact information and Catalogues
- 19 Recommended cable size chart

Welcome

Welcome to the Sterling Power Products Owners Handbook for the Saturn product range. To make things easier for us (and you), we've collated everything into one manual. We're very proud of the Saturn range, they're genuinely the best on the market at this time and we're confident you'll love the item too.

Please take your time to read and fully understand the contents of this Handbook. These guidelines are developed with your safety and the products performance in mind and failure to follow or understand these guidelines may lead to voiding the product warranty or even leading to damage or injury for you or your setup.

If you are unsure of any step or guideline then please consider reaching out to Sterling via our web contact form or our phone service and we shall offer our support.

Thank you for joining the Sterling family and we hope to serve your travels well.

Using this Manual

This manual must be read throughout before installing this electronic device. Do not lose these instructions - keep them safe. The most up to date instructions can be found on sterling-power.com. Please refer to the latest instruction manual before contacting Sterling. At Sterling, we endeavour to include all of the product information that we can think of into the manual.

Installation of the electronic device must be carried out by qualified and trained personnel only. The personnel must be familiar with the locally accepted guidelines and safety measures.

Safety note

Your safety is Sterling's top priority. Please follow all precautions to keep yourself safe. If you believe your unit requires repair then please contact Sterling or your distributor. Do not attempt to service the unit yourself.

Converting 12V for 24V, or 48V

This manual has been written predominantly with 12V nominal voltages in mind. If your input or output voltages on your BB model are 24V models or higher, simply multiply the numbers until they are in the correct threshold. IE, if we are making reference of an output voltage being 14.4V, but your BB has a 24V output, multiply the 14.4V value by two. The charge target voltage then would be 28.8V. The 48V equivalent would be 57.6V.



SAFETY AND LEGAL LEGAL GUIDELINES

Warranty and Terms

Your 100 % satisfaction is our goal. We realise that every customer and circumstance is unique. If you have a problem, question, or comment please do not hesitate to contact us. We welcome you to contact us even after the warranty and return time has passed.

Each product manufactured by Sterling Power comes with at least a 2 year limited factory warranty. Certain Products have a warranty period of time greater than 2 years. Each product is guaranteed against defects in material or workmanship from the date of purchase. At our discretion, we will repair or replace free of charge any defects in material or workmanship that fall within the warranty period of the Sterling Power product. The following conditions do apply:

- The original receipt or proof of purchase must be submitted to claim warranty. If proof cannot be located a warranty is calculated from the date of manufacture.
- Our warranty covers manufacture and material defects. Damages caused by abuse, neglect, accident, alterations and improper use are not covered under our warranty.
- Warranty is null and void if damage occurs due to negligent repairs.
- Customer is responsible for inbound shipping costs of the product to Sterling Power either in the USA or England.
- Sterling Power will ship the repaired or warranty replacement product back to the purchaser at their cost.

If your order was damaged in transit or arrives with an error, please contact us ASAP so we may take care of the matter promptly and at no expense to you. This only applies for shipping which was undertaken by our company and does not apply for shipping organised by yourself. Please do not throw out any shipping or packaging materials. All returns for any reason will require a proof of purchase with the purchase date. The proof of purchase must be sent with the returned shipment. If you have no proof of purchase call the vendor who supplied you and acquire the appropriate documentation.

To make a claim under warranty, call our customer care check telephone numbers on www.sterling-power.com or www.sterling-power-usa.com. We will make the best effort to repair or replace the product, if found to be defective within the terms of the warranty. Sterling Power will ship the repaired or warranty replacement product back to the purchaser, if purchased from us.

Please review the documentation included with your purchase. Our warranty only covers orders purchased from Sterling Power. We cannot accept warranty claims from any other Sterling Power distributor. Purchase or other acceptance of the product shall be on the condition and agreement that Sterling Power USA LLC and Sterling Power LTD shall not be liable for incidental or consequential damages of any kind. Some states may not allow the exclusion or limitation of consequential damages, so, the above limitations may not apply to you. Additionally, Sterling Power USA and Sterling Power LTD neither assumes nor authorizes any person for any obligation or liability in connection with the sale of this product. This warranty is made in lieu of all other obligations or liabilities. This warranty provides you specific legal rights and you may also have other rights, which vary from state to state. This warranty is in lieu of all other, expressed or implied.

Copyright and Plagiarism

Copyright © 2023 Sterling Power. All rights reserved. Reproduction, transfer, distribution or storage of part or all of the contents of this document is strictly prohibited. If you wish to use all of this document, or excerpts from it, Sterling Power must be contacted.

Liability

Sterling Power can not accept liability for:

- consequential damage due to use of this device
- possible errors in the manuals and the results thereof

Device Modification

Please do not modify the device unless you have been instructed to do so by Sterling Power directly. Product modification shall be done at Sterling when needed. Warranty shall be voided if personal attempts are made to modify the device without Sterling's approval.



STERLING
POWER

SAFETY AND LEGAL SAFETY GUIDELINES

Product Guidelines

Your Sterling Power product should only be utilised for its designated purpose. Use the Battery to Battery Charger ONLY:

- For DC to DC power conversion
- With fuses protecting both the input and output DC cables
- In a well ventilated, dry, dust-free and condensation free environment
- When the Owners Handbook has been read and wholly understood

Transport and Storage

Ensure that the mains supply and battery leads are disconnected before transporting or moving the unit. No liability can be accepted for damage in transit once equipment has been unpackaged. Store the product in a dry environment, between -20°C to 60°C .

Refer to the battery manufacturer's manual for information on transportation, stowage, charge rates, recharging and battery disposal for your battery care.

General Maintenance

The device must be switched off during maintenance and all cables removed from the direct feed to or from the unit. It must also be protected against unexpected switching off. Remove battery connections and ensure unit is off. If repair is required, only use original parts. Unauthorised attempts to repair Sterling units will lead to the warranty being voided. Only someone with adequate understanding of electronics and the unit itself should attempt a repair.

Ensure your connections are good and clean and aim to protect your unit from humidity and water ingress.

Safety Precautions

- Electrical appliances can be heavy. Please do not lift heavy units unassisted.
- Ensure that your product is correct for your intent. 12V battery. Incorrect use can lead to damage.
- Orientation is not critical to unit function, however may affect water ingress rating.
- Install device in a well ventilated space for cooling purposes.
- Do not expose the unit to snow, rain, water, spray, condensation, pollution etc, unless it is a waterproof unit. If it is a waterproof unit, only expose it to situations it is correctly rated for.
- Do not cover or obstruct the ventilation.
- Device connects to common negative. Common negatives must be earthed.
- In case of fire, use fire extinguisher equipment suitable for electrical fires.
- Avoid all possibilities of reverse polarity or short circuiting.
- Check cabling and connections frequently and ensure the connections are sufficient.
- Always protect DC cabling with the appropriate fusing.
- Ensure the unit is adequately and safely mounted to prevent displacement and damage.
- Always use a professional to install electrical products.
- Ensure the product is correctly set up for your battery.
- Keep out of reach of children

Cross Voltage Chargers READ THIS

CROSS VOLTAGE THRESHOLD BATTERY TO BATTERY CHARGERS MUST BE INSTALLED WITH CARE
A COMMON NEGATIVE IS PARAMOUNT TO OPERATION, HOWEVER, BE INCREDIBLY CAREFUL NOT TO SHORT CIRCUIT OR REVERSE POLARITY **ANY EQUIPMENT OR CABLE.**

WARNING :

All electrical appliances carry the risk of electrical shock. This equipment is designed to be used in combination with a permanent energy source (the battery). Always isolate the DC before performing any maintenance or inspection.

Do NOT remove the panelling to inspect the internals unless expressly told to by Sterling. This is not a product designed to be user-serviced.

Do NOT use the device in situations where there is danger of gas / dust / vapour explosions, or around potentially flammable produce.

PRODUCT INFORMATION SIMPLE WIRING DIAGRAM

Basic install diagram

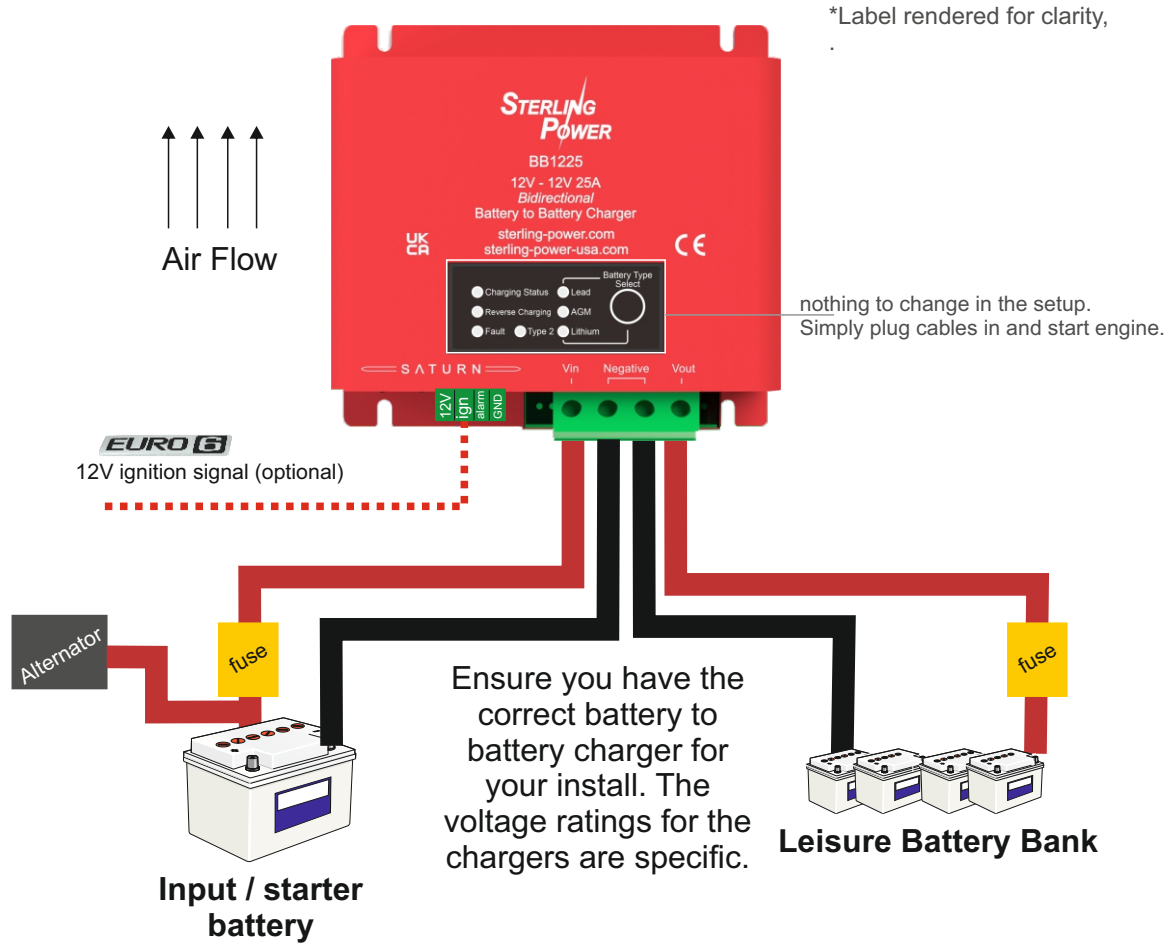

Install summary Above is a basic installation diagram for the Saturn series of charger. If a process is not mentioned, it is likely not paramount to operation. The important notes regarding the install are as follows.

Positive Input The Positive INPUT line must come from a circuit that has either a starter battery or an Alternator Linearisation Device included. It cannot come directly off of just an alternator with no accumulator on the same line. Unit will turn on when either the input voltage is >13.5V or the ignition feed is live.

Positive Output The Positive OUTPUT typically goes directly to a leisure battery bank, but can go to either a bus-bar or any circuit that needs to be powered. If you need the Saturn to operate as a power supply, put it into a lithium profile

Negative The NEGATIVE of the unit MUST be common, and as direct as possible. Avoid chassis points where possible. The starter battery, Saturn and the Leisure battery bank must be all on the same direct-as-possible negative circuit. Both of the negatives on the Saturn are common.

Euro Six / Low Input Voltage If your vehicle is Euro-6/features a smart alternator, you will probably need to use the Ignition feed signal. Alternatively, if you want to signal control the Saturn, you can use the ignition feed. When it is 0V the unit is OFF. When it is 12V~ the unit is ON.

Recommended Cable/Fuses Recommended cabling and fuse sizes are covered on the unit summary/specification pages, pages 7+8.

Any Orientation Suitable

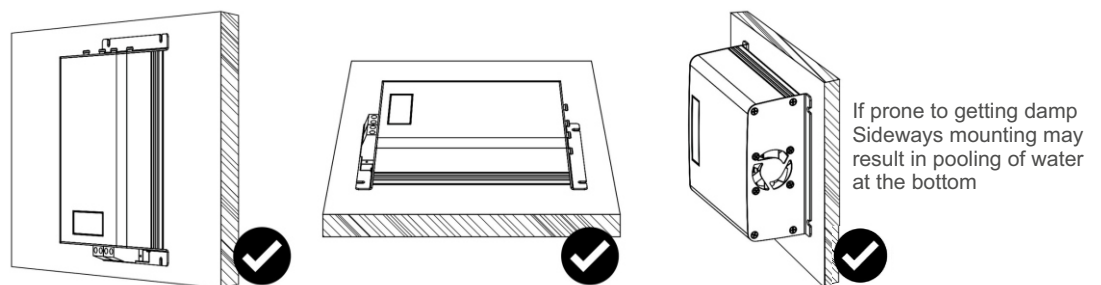



PRODUCT INFORMATION UNIT SPECS AND RECOMMENDED CABLING

Common to all Saturn range BBs

Self recovering protections: under voltage protection
input over voltage protection
output over voltage protection
over current protection
charge over temperature

Operational Temperature Approval -20 Deg C -> 60 DegC
CE | UKCA
E-Marking

Cooling method Thermostatically Controlled
Variable low speed fan

Negative Cable Reverse charge quiescent As thick as the IN cable.
1.5-6W (dependent on rating)

BB1210

Input voltage range 9V-16V
Max Rated output power 9A at 14.41V ~130W
Max Rated input current 10A at 13.68V ~136.8W
Quiescent current 5mA
Efficiency rating 98%

Dimensions 123mm x 130mm x 56mm
Weight 0.6Kg

Terminal diameter 6.1mm
Recommended Input cable 2.5mm² or above (14awg)
Recommended Input fuse 12-15A
Recommended Output cable 2.5mm² or above (14awg)
Recommended Output fuse 12-15A

BB1215 | BB1220

Input voltage range 9V-16V
Max Rated output power 19A at 14.41V ~267.9W
Max Rated input current 21A at 13.68V ~287.3W
Quiescent current 5mA
Efficiency rating 98%

Dimensions 123mm x 130mm x 56mm
Weight 0.6Kg

Terminal diameter 6.1mm
Recommended Input cable 4.0mm² or above (12awg)
Recommended Input fuse 25A
Recommended Output cable 4.0mm² or above (12awg)
Recommended Output fuse 25A

BB1225

Input voltage range 9V-16V
Max Rated output power 24A at 14.41V ~345W
Max Rated input current 26A at 13.68V ~355W
Quiescent current 5mA
Efficiency rating 98%

Dimensions 123mm x 130mm x 56mm
Weight 0.6Kg

Terminal diameter 6.1mm
Recommended Input cable 6mm² or above (10awg)
Recommended Input fuse 30A
Recommended Output cable 6mm² or above (10awg)
Recommended Output fuse 30A

BB1240

Input voltage range 9V-16V
Max Rated output power 38A at 14.41V ~550W
Max Rated input current 42A at 13.68V ~575W
Quiescent current 5mA
Efficiency rating 95-98%

Dimensions 163mm x 130mm x 56mm
Weight 0.8Kg

Terminal diameter 6.1mm
Recommended Input cable 10.0mm² or above (8awg)
Recommended Input fuse 50A
Recommended Output cable 10mm² or above (8awg)
Recommended Output fuse 50A

BB1270

Input voltage range 9V-16V
Rated output power 60A at 13.8V
Rated input current 70A
Quiescent current 10mA
Efficiency rating 92%-94%

Dimensions 200mm x 130mm x 56mm
Weight 1.0Kg

Terminal diameter 6.1mm
Recommended Input cable 16mm² or above (6awg)
Recommended Input fuse 80A
Recommended Output cable 16mm² or above (6awg)
Recommended Output fuse 80A

BB122465

Input voltage range 9V-16V
Rated output power 30A at 27.4V
Rated input current 65A
Quiescent current 10mA
Efficiency rating 92%-94%

Dimensions 200mm x 130mm x 56mm
Weight 1.0Kg

Terminal diameter 6.1mm
Recommended Input cable 16mm² or above (6awg)
Recommended Input fuse 80A
Recommended Output cable 6mm² or above (10awg)
Recommended Output fuse 40A



PRODUCT INFORMATION UNIT SPECS AND RECOMMENDED CABLING

Common to all Saturn range BBs

Self recovering protections:	under voltage protection input over voltage protection output over voltage protection over current protection charge over temperature
Operational Temperature	-20 Deg C -> 60 DegC
Approval	CE UKCA E-Marking
Cooling method	Thermostatically Controlled Variable low speed fan

	BB124865	12V AND 24V IN
Input voltage range	9V-16V / 18V-32V	
Rated output power	16A at 54.8V	
Rated input current	65A / 32.5A	
Quiescent current	10mA	
Efficiency rating	92%-94%	
Dimensions	200mm x 130mm x 56mm	
Weight	1.0Kg	
Terminal diameter	6.1mm	
Recommended Input cable	16mm ² or above (6awg)	
Recommended Input fuse	80A	
Recommended Output cable	4mm ² or above (12awg)	
Recommended Output fuse	20A	

	BB12120
Input voltage range	9V-16V
Max Rated output power	110A at 14.41V ~1584W
Max Rated input current	120A
Quiescent current	5mA
Efficiency rating	92-94%
Dimensions	270mm x 130mm x 73mm
Weight	1.8Kg
Terminal diameter	8.9mm
Recommended Input cable	35mm ² or above (2awg)
Recommended Input fuse	150A
Recommended Output cable	35mm ² or above (2awg)
Recommended Output fuse	150A

	BB1224120	12V AND 24V IN
Input voltage range	9V-16V / 18V-32V	
Max Rated output power	58A at 28.41V ~1540W	
Max Rated input current	120A / 60A	
Quiescent current	5mA	
Efficiency rating	92-94%	
Dimensions	270mm x 130mm x 73mm	
Weight	1.8Kg	
Terminal diameter	8.9mm	
Recommended Input cable	35mm ² or above (2awg)	
Recommended Input fuse	150A	
Recommended Output cable	16mm ² or above (6awg)	
Recommended Output fuse	80A	

	BB1248120
Input voltage range	9V-16V
Max Rated output power	28A at 57.6V
Max Rated input current	120A
Quiescent current	5mA
Efficiency rating	92-94%
Dimensions	270mm x 130mm x 73mm
Weight	1.8Kg
Terminal diameter	8.9mm
Recommended Input cable	35mm ² or above (2awg)
Recommended Input fuse	150A
Recommended Output cable	6mm ² or above (10awg)
Recommended Output fuse	40A

	BB12200
Input voltage range	9V-16V
Rated output power	180A at 13.8V
Rated input current	200A
Quiescent current	15mA
Efficiency rating	95%-98%
Dimensions	309mm x 130mm x 96mm
Weight	2.2Kg
Terminal diameter	14mm
Recommended Input cable	70mm ² or above (00awg)
Recommended Input fuse	250A
Recommended Output cable	70mm ² or above (00awg)
Recommended Output fuse	250A

Faceplate Diagram

*Label rendered for clarity,



1. The top mounting plate. Composed of 2x 5mm wide mounting feet. There are 2x 5mm wide mounting feet at the bottom, too.
2. Location of 2x heat extracting fans. The air is sucked through the BB and the direction of air flow is demonstrated above.
3. Display panel. More information on page 9.
4. Connection blocks. This region is described in more detail overleaf. This is the area where all the physical installation connections to the BB1248120 are made. Also, this region contains additional 2x 5mm mounting feet.

Base Diagram

*Label rendered for clarity,

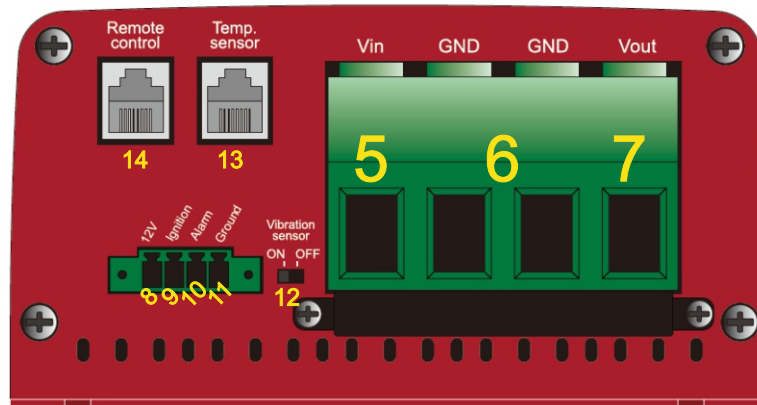

5. The left large green connector is for direct connection to the input / starter battery. 12V input connection. Ensure the cable thickness is 35mm² / 2AWG. Ensure this cable is fused at ~150A fuse.
6. These 2 central connectors are for common negative cable. For convenience, use the left GND to connect to the input battery's negative and use the right GND connector to connect to the output battery's negative. Use similar sized cable as positive.
7. The right large green connector is for direct connection to the output / leisure battery. 12V output connection. Ensure the cable thickness is 10mm² / 8AWG. Ensure this cable is fused at 40A fuse.
8. This 12V output provides a 12V signal at 50mA. This can be used to trigger an operation / provide a 12V signal. This 12V signal shall only become live if the Ground connector (11) is connected to the common negative rail.
9. Ignition feed connector. The BB1248120 can be operated based on an ignition signal - this is recommended if you have a smart alternator (Euro 6 engine). Wire a feed from your ignition into this terminal. Ensure that this feed is ~12V when the ignition is live and goes to 0V when ignition is turned off. Once the BB1248120 receives its first successful ignition signal it shall render the unit dependent on an ignition signal going forward. Therefore, the BB shall not operate based purely on input voltage coming from the input battery but based on whether your ignition is live or not. You can reset this feature by removing the ignition feed and pressing / holding the front button down for 15 seconds and letting go.
10. Alarm. If the BB faults - this alarm connector shall put out a live 12V | 100mA. Therefore, you can wire in an audible 12V alarm or a 12V light / LED to convey a fault. These are optional fits. You can also use this connector to relay a 12V signal to another device to prompt an action if the BB were to fault. Ground connector (11) must be connected to the common negative rail for this alarm output to operate. More information on page 11.
11. Ground. To utilise connectors 8 or 10, a ground / negative (0V) feed needs to be connected here. For the ignition feed connector to operate, a negative feed is **NOT** required.
12. Vibration sensor on / off switch. Default off. If turned on, the BB1248120 shall begin charging when the vibration sensor detects 2x vibration events. This shall override the ignition signal and allow you to install the BB without the need to install an ignition signal. This is also an operational method if you have a smart alternator / Euro 6 engine (or younger). This mode comes with cautions, please read page 10. Switching between on / off can be done at anytime. There may be a 10 second delay in unit operation between switches - no need to reset / reconnect the BB.
13. Temperature sensor connector. Here is where to install the temperature sensor - TEMP1. Connect the terminal end of the temperature sensor to the negative terminal of the output battery. If in a Lead or AGM setting the temperature sensor compensates the voltage being delivered by the charger based on sensor temperature. If in a lithium setting, there is no voltage compensation. In lithium, the charger stop charging if sensor detects 0DegC or lower.
14. Not applicable / local use only

PRODUCT INFORMATION ITEM CONTROLS AND UNDERSTANDING

LED panel

Charging Status :: 1)

Orange LED status:
 Fast flashing = Bulk / Fast Charge
 Slow flashing = Absorption
 Solid = Float

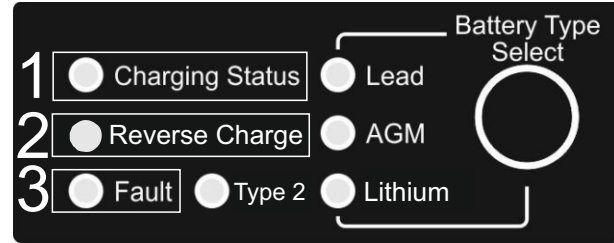

Reverse Charging :: 2)

This LED shall turn on when the BB has engaged the reverse charge circuit, charging the input battery. The reverse charge circuit engages when the output battery is >13.5V / 27V / 54V

Disabling Reverse Charging

To remove this feature, press and hold the Select button for 20 seconds - after you see the LEAD AGM and Lithium LEDs stop flashing then release. You can now use the Select button to toggle the Reverse Charging LED on / off. On = reverse charge. Off = no reverse. Then simply leave it to settle to confirm your selection.

Jump Start Assist





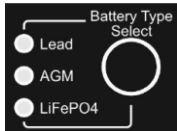



To manually force the reverse charge process, simply press the Select button 4 times in a row. The Reverse charging LED should come on.

Battery Type Select



This section displays what battery type you are currently in. To configure this :
 When charger is on, press and hold the Select button for 5 seconds until the LEDs flash. Then, press the Select button to toggle through the 6 different battery types - the flashing orange LED shall depict the battery type. Type 2 LED shall light up to display the second profiles of the battery types. Once you have the LED on the target battery type, stop pressing the button and wait until the LED stops flashing - after a few seconds the flashing stops and the LED stays on solid - this confirms setting.

Battery type profiles:

LED sequence	Battery Type	Absorption (V)	Float (V)
 Lead	Lead I	14.4V	13.3V
 Type 2 +  Lead	Lead II	14.6V	13.5V
 AGM	AGM I	14.2V	13.1V
 Type 2 +  AGM	AGM II	14.7V	13.6V
 Lithium	Lithium I*	14.4V	13.8V
 Type 2 +  Lithium	Lithium II*	14.2V	13.6V

These profiles are with 12V configuration in mind.

For 24V output chargers, multiply the values by 2.

For 48V output chargers, multiply the values by 4

Lithium profile properties

Lithium* = live output voltage, ideal for waking up BMS on batteries. Please ensure your lithium battery has an internal or external BMS. If temperature sensor is connected, no voltage compensation on lithium profiles occurs, instead charge is disabled if the batteries are measured at ODEGC.

Absorption Timers

As the BB can measure both current and voltage it shall make an intelligent decision as to when to transfer from absorption to float mode. This algorithm detects both the rate of rise of voltage and the rate of decline of current. If the target absorption voltage has been met and the current has dropped to a few amps the charger shall transfer to float mode.

Going from Float to Absorption



If the output voltage at the Saturn charger is pulled down by 0.7V from the float voltage, the absorption charge process will restart automatically.

The fault LED will illuminate if the Saturn charger has detected a problem. Consult the troubleshooting page at the back of this manual to see what has gone wrong and how to resolve it.

ENGAGEMENT MODES SATURN RANGE INSTALLS, 3x ENGAGEMENT METHODS

Automatic Mode (Default)

This mode is the simplest way to install the Saturn charger, however, not the most effective if you are using this BB on a modern vehicle that has regenerative braking or a poor input voltage (Euro 6 engine or newer).

To activate the BB, you require 13.5V+ on the input terminal. You shall achieve this voltage by charging up your input battery (starter battery) with an alternator (for example).

When the input voltage drops below 12.8V (when you turn your engine off), the BB shall turn off and go to sleep.

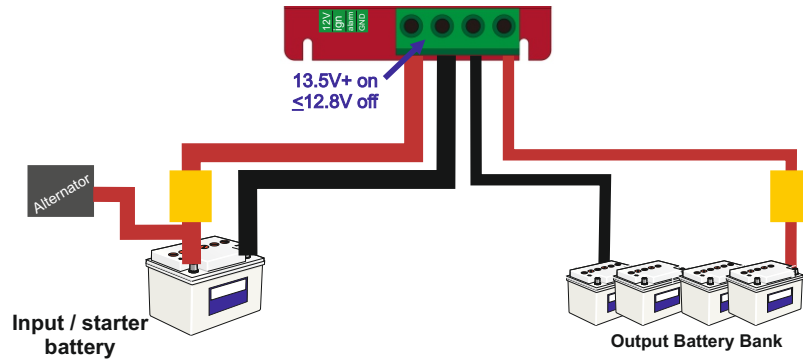

EURO 6

Ignition feed Mode (requires 12V signal feed)

In this mode you control the BB based on an ignition signal. Whenever this signal line is live (5V-32V) the unit will be online.

The Saturn charger will work with this ignition signal all the way down to an input voltage of 11.0V, at which point it will automatically turn off to protect your starter battery.

The Ignition feed engagement gives you the most binary on/off control of the charger, but can also lead to your starter battery being discharged if the ignition line is live but the starter battery is not supported with a charger or alternator feed at the same time.

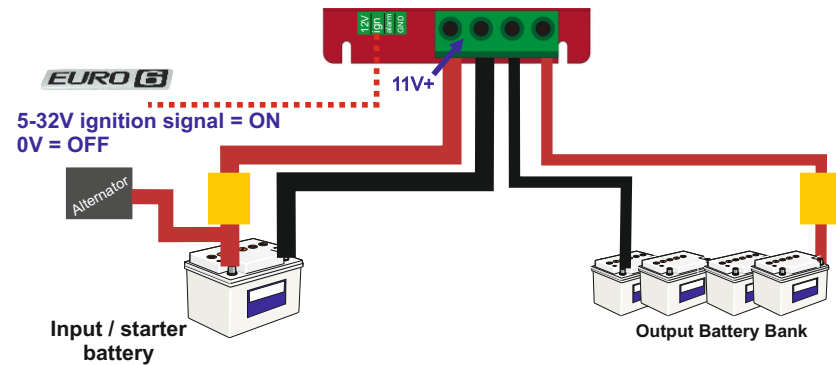

By applying a live signal to the ignition connector you put the BB into ignition dependent mode. The BB shall NOT work unless it has a live ignition signal - even if you remove the ignition feed cable and provide 13.5V+ onto the input terminal.

- To reset the BB back to Automatic Mode, ensure BB is on -
- I) Remove ignition cable from ign connector.
 - II) Press and hold SETUP button for around 15 seconds until the 3 LED battery types flash at the same time.
 - III) Release button and charger reverts to Automatic Mode.

EURO 6

Vibration sense Switch position ON.

This mode requires the BB to detect 2 vibration events in order for it to turn on and charge. For example, turning an engine on shall provide sufficient vibration to get the BB to begin charging.

This mode essentially acts like an ignition signal and is designed for installers to do away with having to run an ignition feed.

WARNING, if vibration signal activates BB may drag starter battery voltage to below 11V. Possible flat starter battery! The BB does monitor the input battery and shall turn off after 2 minutes if the voltage does not climb up.

Input voltage + vib. sense.
Charger on - 11V -> 16V
Charger off - <10V

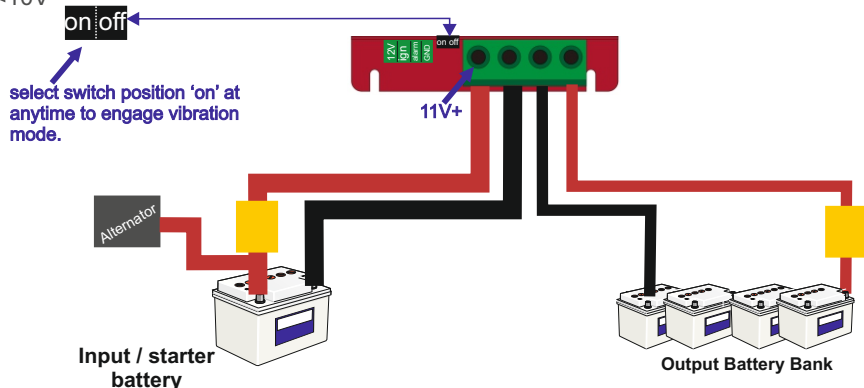



STERLING
POWER

Multiply voltages by 2 for 24V, 4 for 48V.

TROUBLESHOOTING AND PROBLEM RESOLUTION

Verify Install : Negatives

As with all things, if you suspect a problem, please ensure the install is correct. Ensure negatives are common where possible and the BB charger's negative is connected to the starter battery's negative - avoid connecting to chassis negative. Voltages between common negatives should be ~0V.

Pre-Troubleshooting

Ensure that all other charge sources (Solar, AC/DC, Wind) are isolated so as to not affect upcoming readings.

Measure Voltages

Turn on your engine and, with a multimeter, measure the voltage on the INPUT and OUTPUT terminals of the Saturn charger, using the units negative as reference. Record these numbers down. If you do not know how to measure voltages with a multimeter, please call for an electrician.

Saturn Engagement Requirements

The Saturn will turn on automatically when the input voltage is >13.5V if in auto-voltage sense. If an ignition feed has been inserted to the unit, the Saturn will turn on when the input voltage is >11V and the Ignition feed is >5V.

Charger is fine :

If your input voltage is >13.5V and your output voltage is 13V-14.6V and rising towards the profile target voltage, chances are the unit is working correctly. Check voltage at leisure batteries to ensure it's the same.

Output voltage correct, but not reaching batteries

If the output voltage from the charger seems to be correct (IE it has reached absorption 14.4V correctly) but you do not have the same voltage at your batteries, you either have significant volt-drop down the output circuit (IE poor contacts, thin cable, poor continuity) or the leisure battery simply is not connected (wiring mishap, blown fuse). Check the system until voltage at the output of the charger and voltage at the destination are equitable.

Input voltage healthy but output voltage low

If your output voltage is less than what you would expect it to be, there are a few possibilities
A) Your battery was very depleted and is still drawing power. Watch to see if the output voltage is rising.
B) You may have a heavy load on the leisure battery, pulling all of the power from the charger immediately, simply turn off the associated load.
C) The Saturn may be in a fault state, or potentially has failed.
D) The Saturn may not be online. Check LEDs on the item and ensure they are lit. If the input voltage is good but the charger is not responding, it may be in vibration sense or ignition feed modes.

Input voltage low/struggling Euro 6:

If your input voltage is low when the engine is on (<13.5V) there are a few possibilities. Modern automotives may have smart alternators or Euro 6 systems. By default (and to save fuel economy) these alternators will only engage when the starter battery or starter system is in need of power. To overcome this limitation, install the ignition feed to the unit.

Loss down cable

If the voltage at your starter battery is being maintained at a healthy ~14V, but the input voltage at the Saturn is significantly lower, you either have significant loss in the circuit or you have a continuity error. Check contacts and ensure that the cable is thick enough to resolve this volt-drop.

Weak or failed alternator

If the voltage at the starter battery is also low and it is not due to the Euro 6 nature of the vehicle, it is likely that the alternator simply cannot support the load. This is either due to the Saturn item being too powerful for the associated alternator at current RPM, or the alternator having deteriorated/failed.

Output voltage higher than expected

Check if the temperature sensor is fitted. If the temperature sensor is fitted, you may simply be going through temperature compensation. If it is not fitted, check for other chargers being active, or check voltmeter calibration.

Lower output current than expected

This is likely due to a sagging input voltage. If our input voltage cannot be sustained above 13.5V we will automatically downrate to 85% or 65% operation. Input voltage must recover (13.8V) to return to full power.

input voltage	Operation%
>13.6V	100
12.8V - 13.6V	85
<12.8V	65

Fault Table

Problem	Possible Cause	Suggested solution	Recovery Condition
Low Voltage Disconnect (LVD) on input - in Auto Mode	input voltage is lower than 12.8V or no ignition signal is detected.	Turn engine on ensure cable thickness between input and starter battery is sufficient.	The fault shall clear automatically when input voltage rises above 13.5V.
Low Voltage Disconnect (LVD) on input - in Ignition / Vibration Mode	input voltage is lower than 10V and/or no ignition signal is detected.	Turn engine on ensure cable thickness between input and starter battery is sufficient. ~12V at ignition	The fault shall clear automatically when input voltage rises above 11V + live ignition / vibration signal
Output Over Voltage Protection (output OVP)	output voltage has exceeded 0.6V+ on top of set absorption voltage.	check loads or chargers on output battery. Check where high V is coming from	When output voltage drops below 0.3V on top of set absorption voltage the BB resumes charge.
Input Over Voltage Protection (input OVP)	input voltage has exceeded 16V.	likely alternator voltage has gone too high. If Euro 6 vehicle - this is okay, BB shall reboot when V drops.	When voltage drops below 15.5V the BB shall turn on and resume charging after 30 seconds.
Over Temperature Protection (OTP)	Charger's internal temperature is too high	Check input and output exhausts for blockages. 10mm	When charger temperature reduces charging resumes
Fan Fault	Failed fan	objects may be jamming the fan, fan may be old, clogged up.	When fan is operational the fault light turns off.

BBR SATURN CHARGER REMOTE CONTROL

Welcome The BB remote control (BBR) is designed to be used with Sterling Power's range of Buck Boost Battery to Battery Chargers (red casing with white text). The BBR is both a passive display of information and a remote control that can input and modify the behaviour of the BB.

Installation The remote comes with 4m of extension cable and the appropriate adapter. The remote can be flush mounted, surface mounted or recess mounted. The tabs on the wings of the remote control can be taken off and 4x screw holes can be used.

Power The remote is powered from the BB, so will only be live when the charger is live.

connect cable to this port on BB

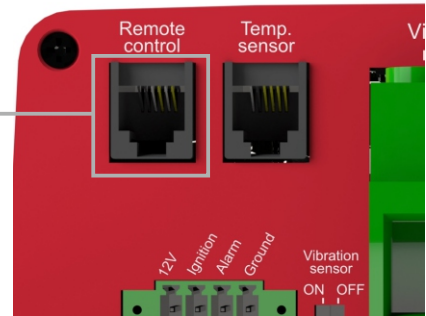

When the remote is connected to the BB, the remote will display the settings that are presently programmed into the BB. With the remote connected, changes can be made using the display interface.

Diagram

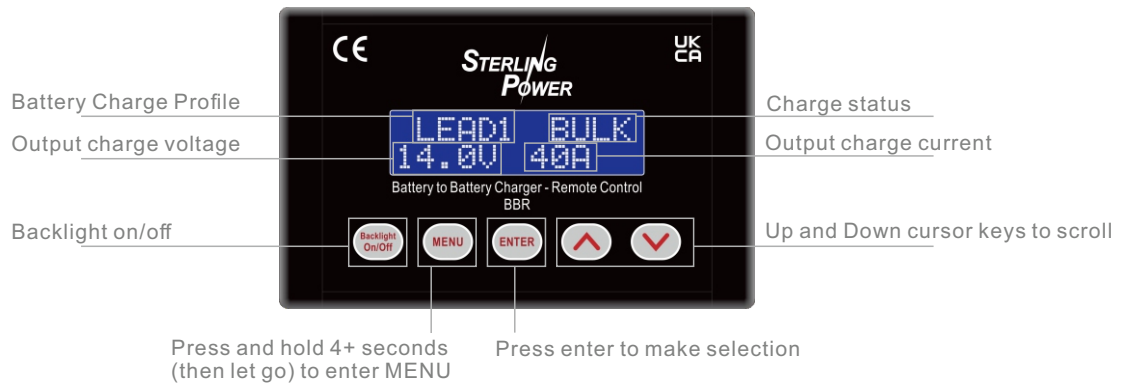

2 main display screens



Making functional changes

Below is a list of functions that can be selected by the remote control. More information overleaf.

To access and adjust settings, press and hold the **MENU** button for 4+ seconds and let go. You can then toggle through settings by using the arrow keys, and selecting settings by pressing enter.

Settings

- Battery type - here you can change battery type, you can also select user defined setting (custom) - the custom profile is adjusted in the User Defined 1 and 2 settings below.
- EQ Mode - Enabling EQ mode shall put the BB into a desulphation cycle. Warning high voltage.
- Float on/off - Here you can turn off float mode - only available in lithium
- Ign - Ignition mode, you can toggle whether the BB is in ignition mode or not. (on/off)
- Backlight - Here you can adjust how long the backlight stays on after you press a button (All, 10s-250seconds).
- Set Current - here you can adjust the current levels to 65%, 85% or 100%.
- User defined setting 1 - here you can adjust absorption voltage, float voltage and absorption time lengths
- User defined setting 2 - here you can adjust absorption voltage, float voltage and absorption time lengths
- **SAVE AND EXIT** - This is **CRITICAL** if you want to save the settings you have changed, they will otherwise be forgotten.

BBR SATURN CHARGER REMOTE CONTROL

Battery type	Press ENTER - toggle between LEAD 1 +2, AGM 1+2 and both the lithium profiles or the User Defined Settings 1+2. This can be set further down the menu list.
EQ mode	This mode puts the BB into a desulphation charge voltage of 15.5V (only appears when in LEAD mode) - use toggle up and down to adjust.
Turn Float on or off	This mode turns float mode on or off (only available when in LITHIUM) - use toggle up and down to adjust
IGN	If the BB has been put into ignition feed mode, here you can take the BB out of ignition feed mode. Simply toggle up and down with arrows to select the desired on/off.
Backlight	Backlight timer can be set here. After you press a button the remote, you can define how long the screen remains on for. 10s - 250 seconds. There is also an 'ALL' selection. This means the screen is on all the time, whilst the charger is running. On all the time shall allow you to view what the BB is doing whilst driving and the BB charging.
Set current	The default current setting for the BB range is 100% - meaning that the performance default is full power. If you wish to reduce the performance of the BB, here you can set to 85% or 65% charge rate. Examples of why you may wish to reduce performance: 1) if you have solar panels and the weather is good, by reducing the power of the BB, you shall conserve fuel. 2) The alternator is better suited running at slightly lower current than what was expected. 3) It may be recommended by your battery supplier to charge the battery up at a slightly lower current. If one of your lithium batteries within your leisure battery bank fails, you may be exceeding the C rating of the remaining batteries. 4) future proofing. If you have installed a high powered BB, in the assumption that one day you shall put a larger alternator on and/or more batteries in your system. You can reduce the power for the immediate install and increase the performance of the unit at a later date.
User define1 set	If you enter User define1 set you can customise the charge profile and absorption time length. The first measure to adjust is the absorption voltage (14.0-15.5V) - use the cursor keys to adjust up or down the absorption voltage, then press ENTER. The next option is float (12.6V - 14.0V) - use the cursor keys to adjust and press ENTER. The last option is absorption time length in hours (0.5hr - 6.0hrs) - press enter to confirm. Once you have confirmed go back up to Battery type and select 'user define1'.
User define2 set	If you enter User define2 set you can customise the charge profile and absorption time length. The first measure to adjust is the absorption voltage (14.0-15.5V) - use the cursor keys to adjust up or down the absorption voltage, then press ENTER. The next option is float (12.6V - 14.0V) - use the cursor keys to adjust and press ENTER. The last option is absorption time length in hours (0.5hr - 6.0hrs) - press enter to confirm. Once you have confirmed go back up to Battery type and select 'user define2'.
Save and Exit	If you have made changes within the SETUP procedure and you wish to save these settings - you must press ENTER on Save and Exit.
No Save and Exit	If you have made changes within the SETUP procedure and you DO NOT wish to save these settings - you must press ENTER here.

BBR dimensions - not to scale

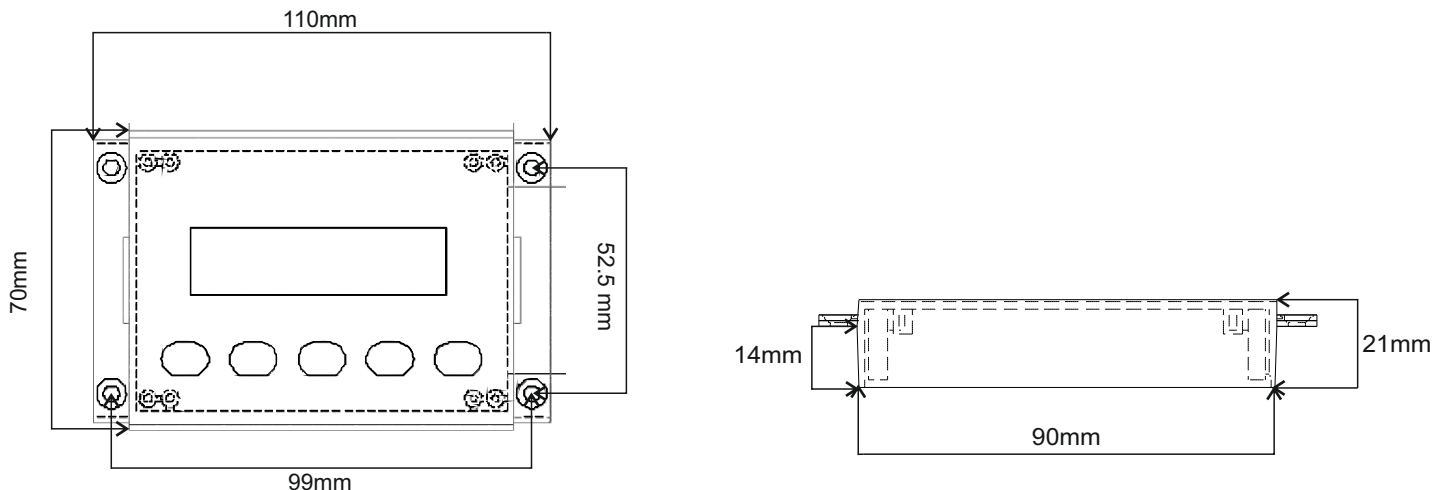

TECHNICAL DIMENSIONS SATURN DIMENSIONS, NOT TO SCALE

BB1210
BB1215
BB1220
BB1225

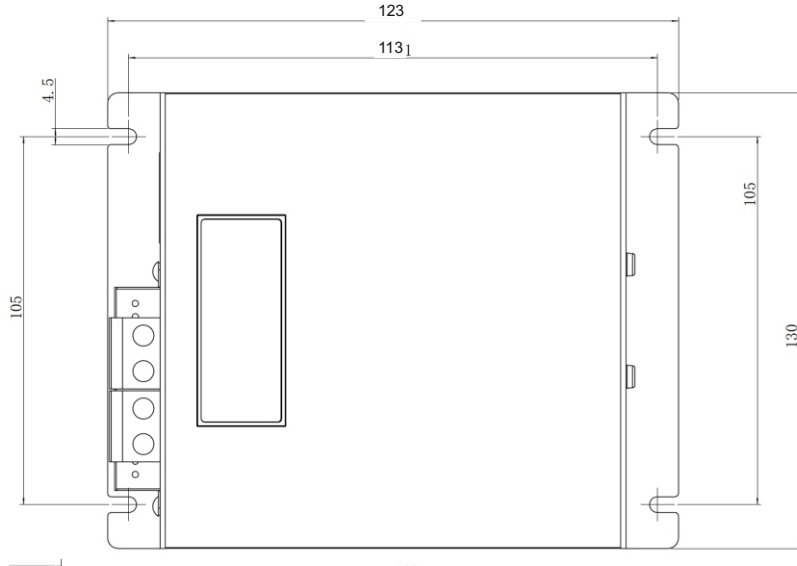

BB1240

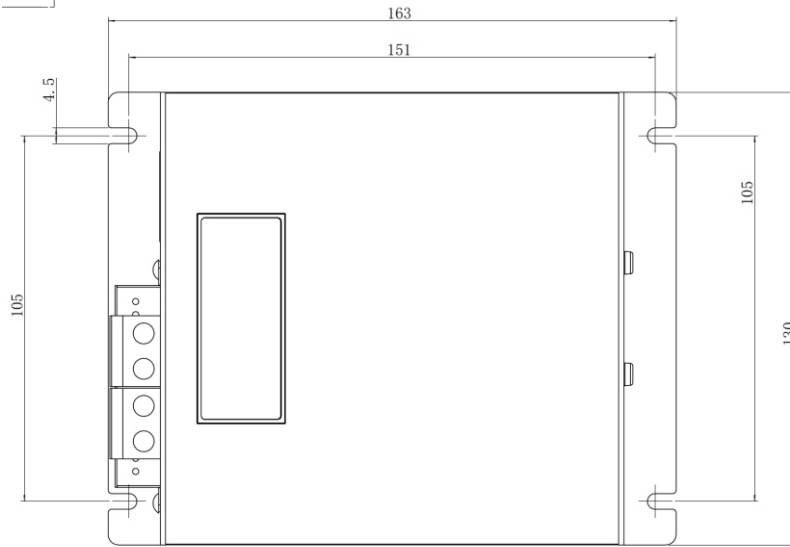

BB1270
BB122465
BB124865

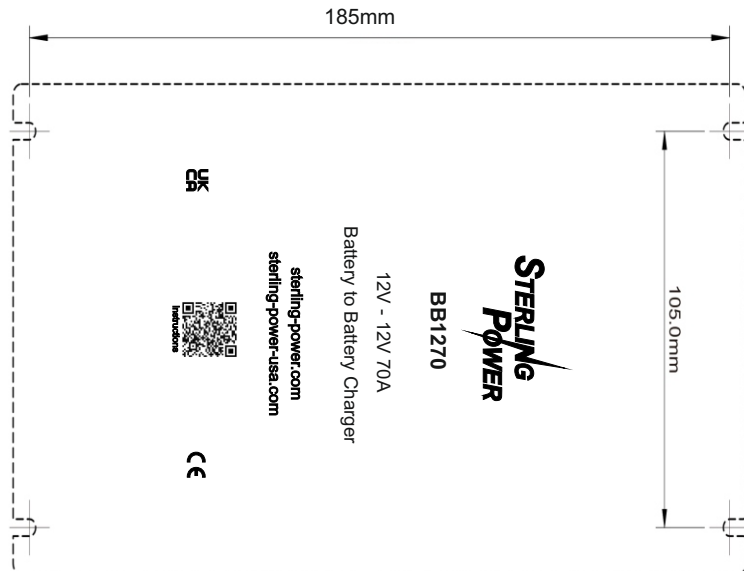

TECHNICAL DIMENSIONS SATURN DIMENSIONS, NOT TO SCALE

BB12120
BB1224120
BB1248120

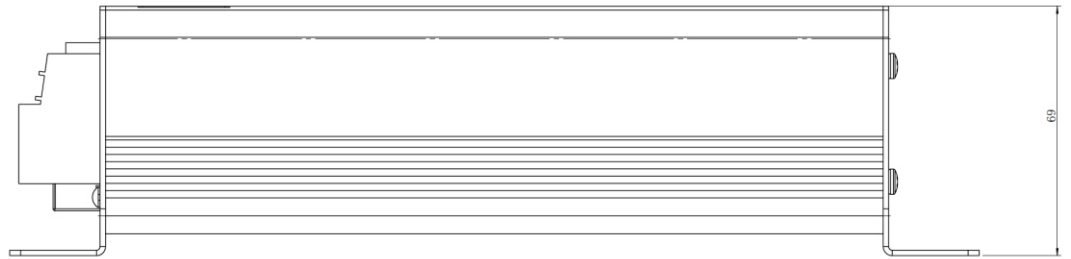

BB12200

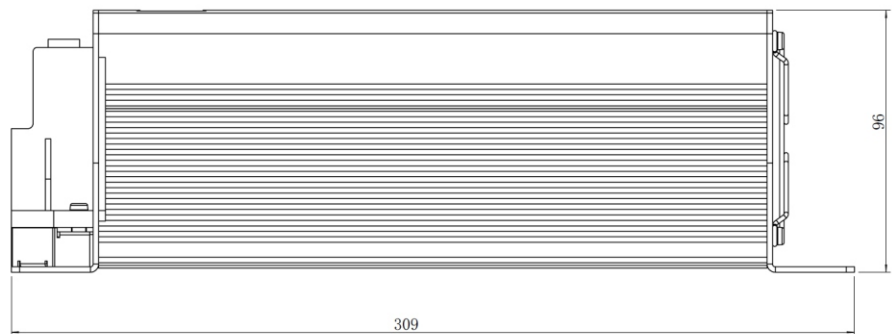
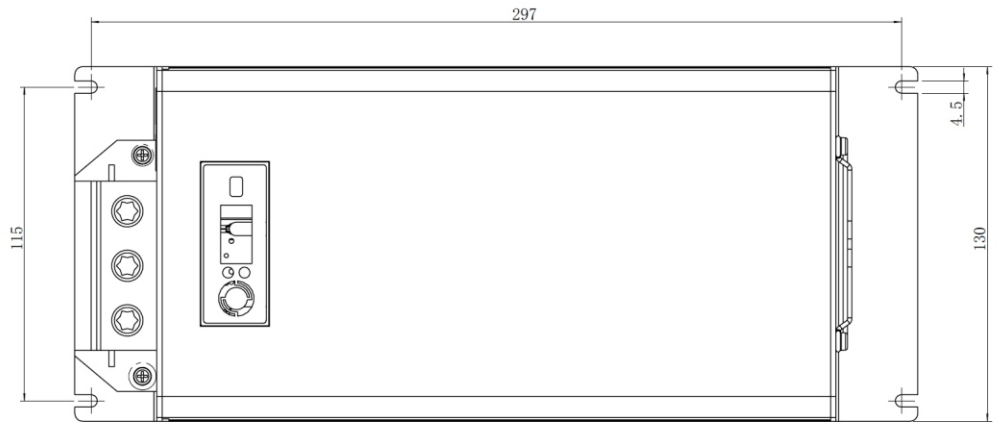

Thank you for considering Sterling. Happy travels.

Further consideration

If you are interested in placing an order or asking a question, please contact info@sterling-power.com

Automotive Catalogue
A

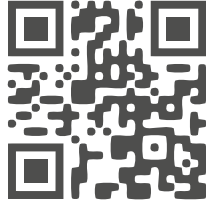

Accessories Catalogue
C



Marine Catalogue
B

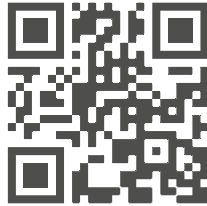

AMPS Lithium Catalogue
D



Voltage drop specification

Higher voltage drop
Lights, pumps
Non Critical equipment

Low voltage drop
Inverters, chargers
Critical equipment

Cable length meters

Cable length (m)	0-6	6-9	9-15	15-19	19-24	24-30	30-40	40-51	51-61
0-2	0-2	2-3	3-4.5	4.5-6	6-7.5	7.5-9	9-12	12-15	15-18
18-21									
21-24									
24-27									
27-30									
30-33									
33-37									
37-40									

Safety regulations demands any cable directly connected to a battery source must be fused
Required Current based at approx 60 deg C 12V
Warning: this is total cable length not distance to product remember to add the pos and neg cable length as total

This chart for general reference only, cables sizes vary with ambient temperatures and other aspects
Use only multi strand cable not solid core cable.

AWG American Wire Gauge

AWG	Copper diameter mm	Copper Cross sectional mm sq
16	1.29	1.5
14	1.63	2.5
12	2.05	4.0
10	2.59	6.0

AWG	Copper diameter mm	Copper Cross sectional mm sq
8	3.26	10.0
6	4.11	16.0
4	5.19	25.0
2	6.54	35.0

AWG	Copper diameter mm	Copper Cross sectional mm sq
1	7.35	50.00
0	8.25	60.00
00	9.27	70.00
000	10.40	95.00
0000	11.68	120.00

For unknown cable simply measure **copper conduit** diameter and equate to the above chart. do not measure the cable insulation diameter. The mm sq figure is rounded up for Euro cables.

Sterling Power Copyright

